

CORNER14 EF/TY

CORNER PROFILE / PROFIL KĄTOWY

max 14 mm

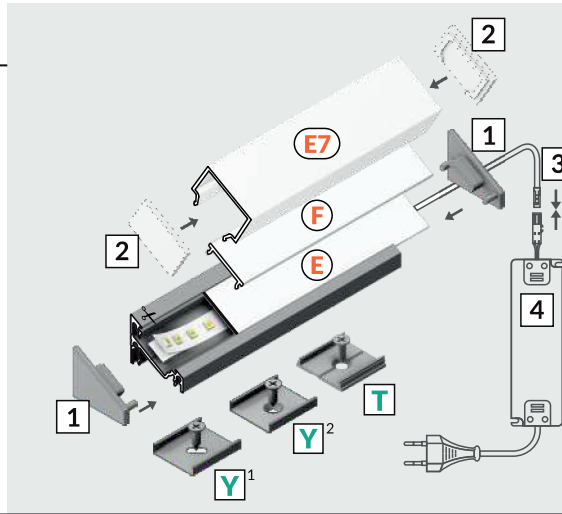
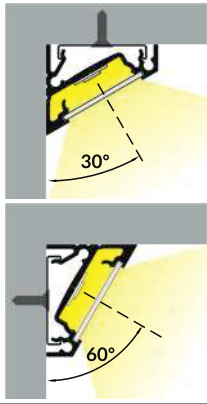
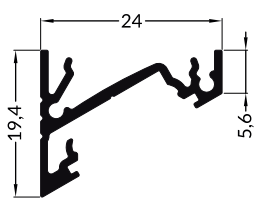

- E** E slide cover
klosz E wsuwany
- F** F click cover
klosz F klik
- E7** E7 click cover
klosz E7 klik
- Y¹** Y flexible mounting plate
uchwyt Y sprężysty
- Y²** cone Y flexible mounting plate
uchwyt Y sprężysty cone
- T** T mounting plate
uchwyt T
- 1** CORNER14 ending gen2
zaślepka CORNER14 gen2
- 2** E7 ending
zaślepka E7
- 3** power supply cable
kabel zasilania
- 4** LED power supply
zasilacz LED

- scissors**
nożyczki
- hacksaw**
piłka
- pliers**
kombinerki
- solder**
cyna
- soldering iron**
lutownica
- screwdriver**
wkrętak
- drill**
wiertarka

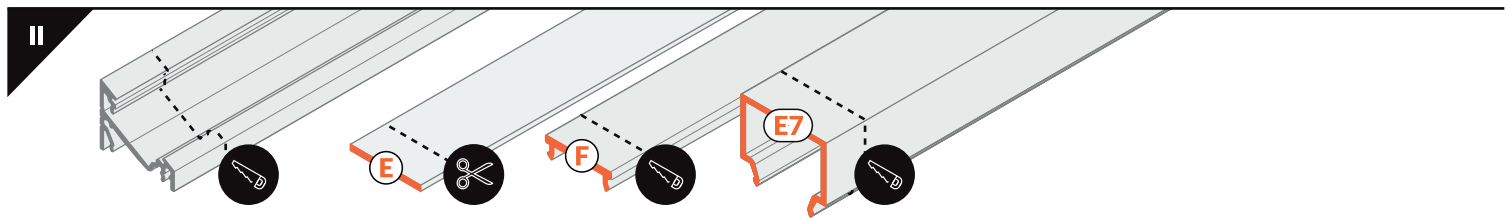
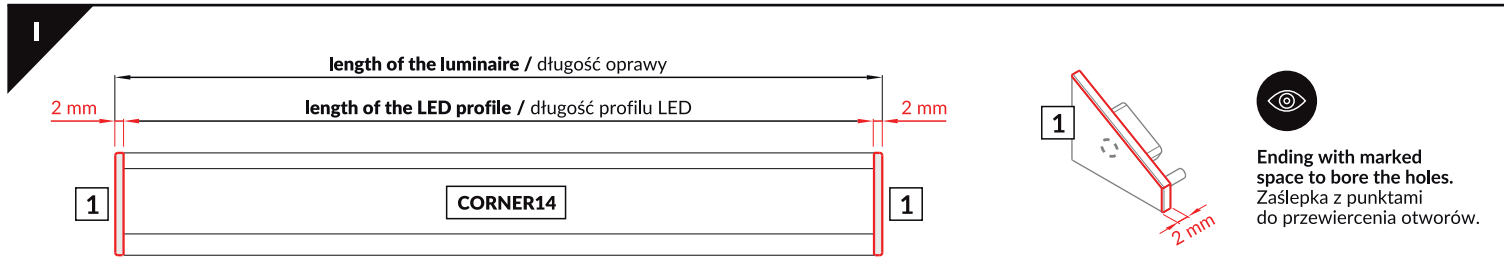

The length of the cover is equal to the length of the profile. / Długość klosza równa jest długości profilu.

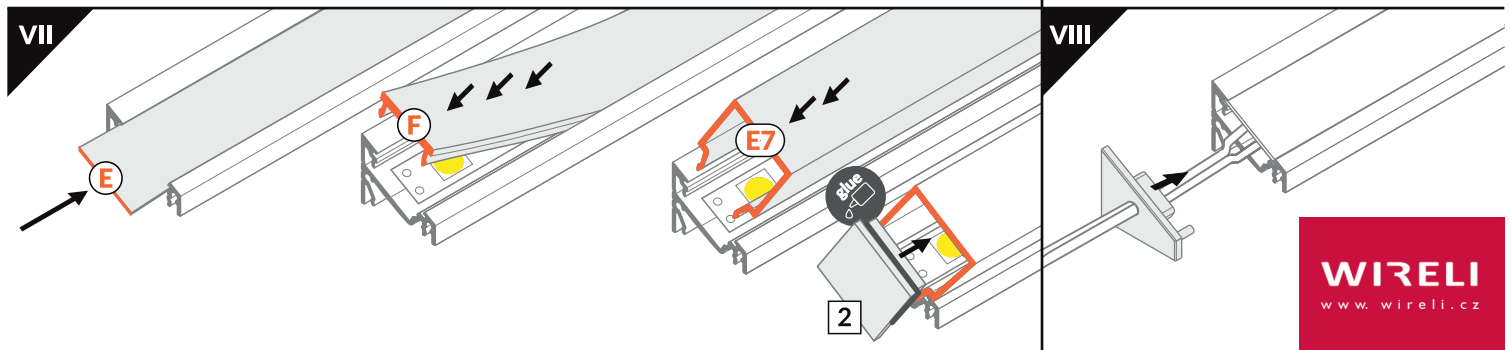
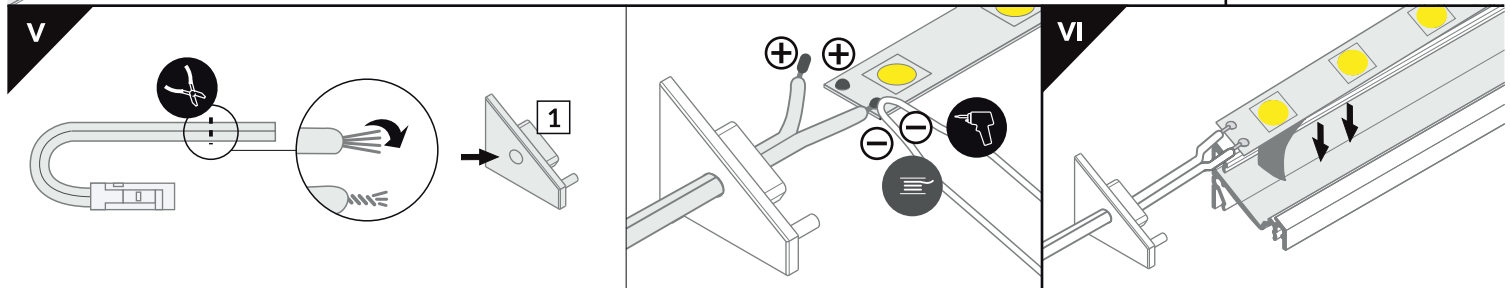
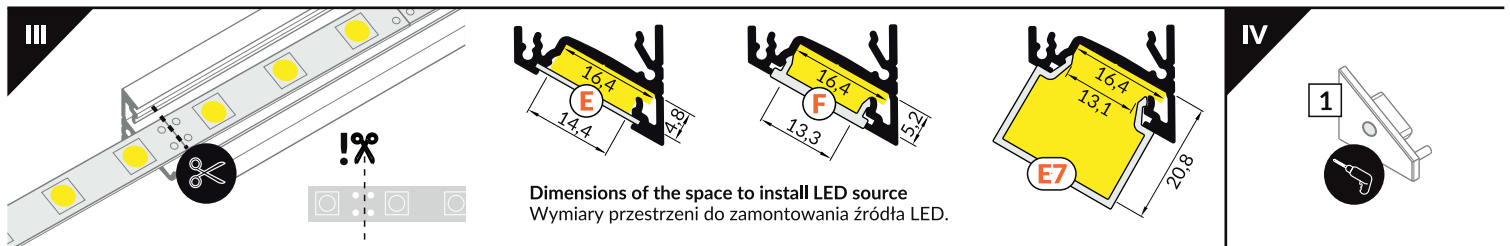

IX MOUNTING / MONTAŻ

Y flexible mounting plate
uchwyt Y sprężysty

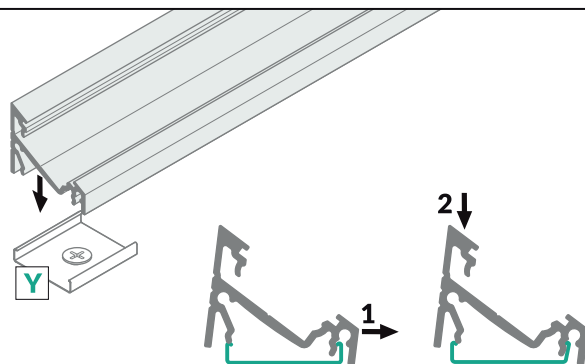
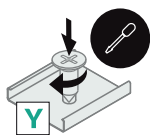
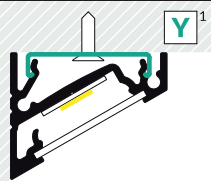

cone Y flexible mounting plate
uchwyt Y sprężysty cone

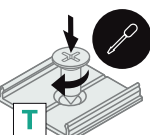
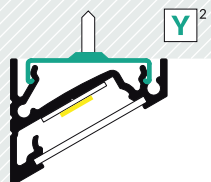

T mounting plate
uchwyt T

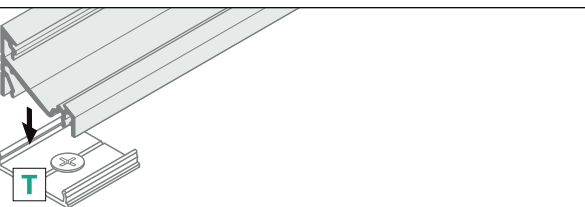
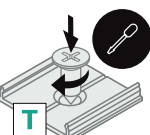
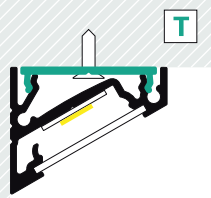

Other mounting possibilities: with mounting glue or mounting tape, with screws
Pozostałe możliwości montażu: na klej lub taśmę montażową, na wkręty

X POWER SUPPLY / ZASILANIE

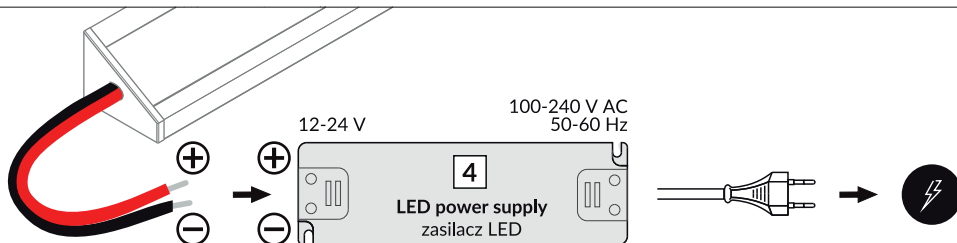

OPTIONAL ACCESSORIES / AKCESORIA OPCJONALNE



Mount the connector before installing the LED strip. In case there is no possibility of sliding the profile into connector it is recommended to mount with screws, directly to the mounting surface / Łącznik montować przed instalacją taśmy LED. W przypadku braku możliwości wsunięcia profilu w element łączący zalecany jest montaż na wkręty, bezpośrednio do powierzchni montażowej

T connector 180 deg
łącznik T 180 st

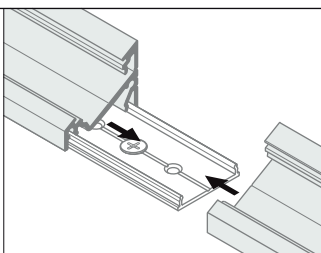
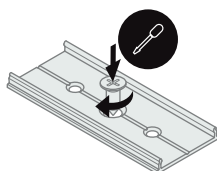

T connector may be used to make extra long profiles by connecting multiple profiles.
Łącznik T może być użyty do stworzenia pojedynczego bardzo długiego profilu.

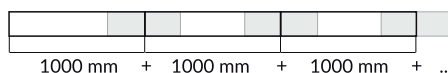

CORNER14 connector 90 deg
łącznik CORNER14 90 st

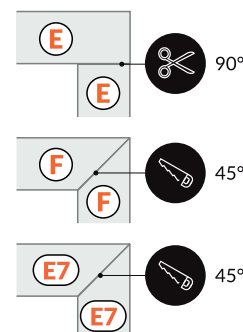
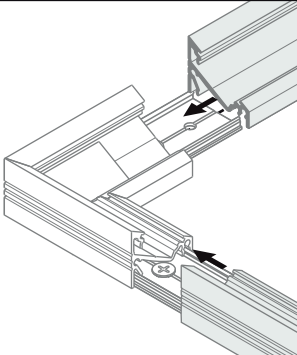
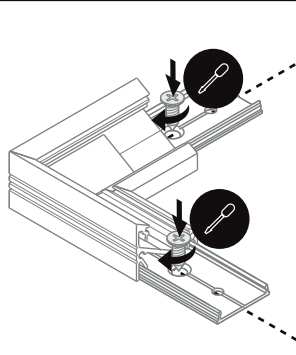
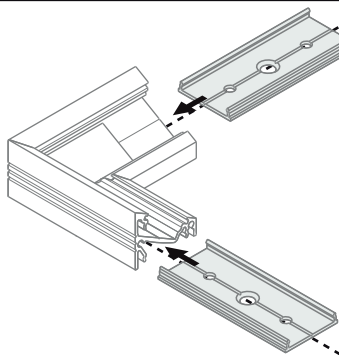

ACCESSORIES / AKCESORIA

power switches / włączniki
controller + remote / sterownik + pilot
movement sensors / czujniki ruchu