

CABI12 E

CORNER PROFILE / KĄTOWY

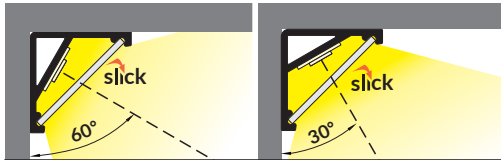

scissors
nożyczki

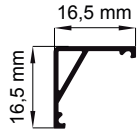
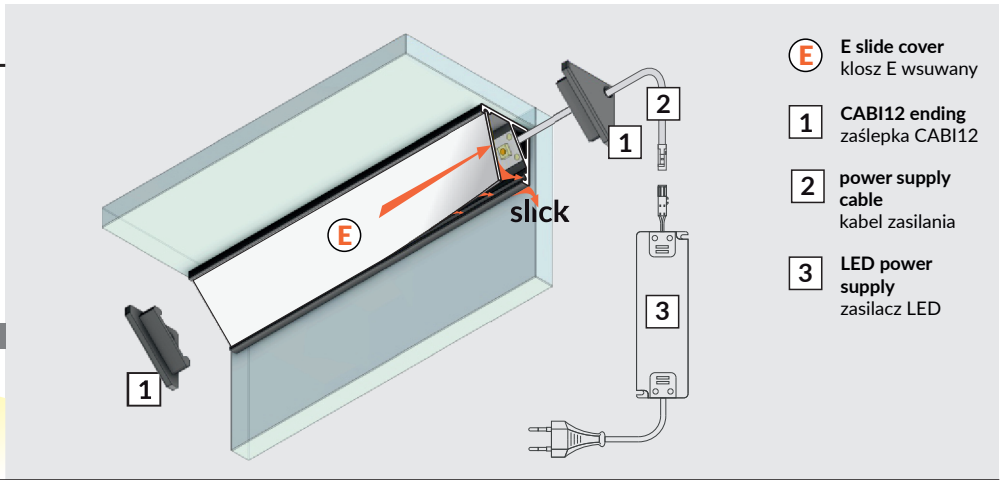

pliers
kombinerki



soldering iron
lutownica



solder
cyna



glue
klej

E E slide cover
klosz E wsuwany

1 CABI12 ending
zaślepka CABI12

2 power supply cable
kabel zasilania

3 LED power supply
zasilacz LED

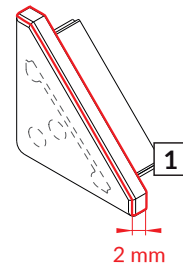
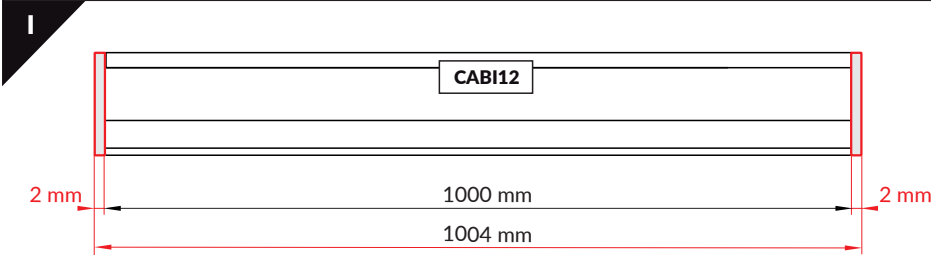

The ability to drill through ending to conduct the wire, if necessary.
Możliwość przewiercenia zaślepki w razie potrzeby przeprowadzenia przewodu.

Note! Ending thickness increases the length of the luminaire (+ 2 x 2 mm).
Uwaga! Grubość zaślepki zwiększa długość oprawy (+ 2 x 2 mm).

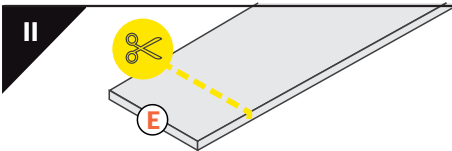

The length of the cover is equal to the length of the profile.
Długość klosza równa jest długości profilu.

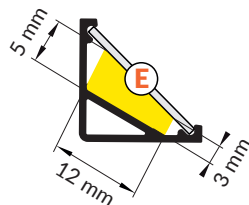
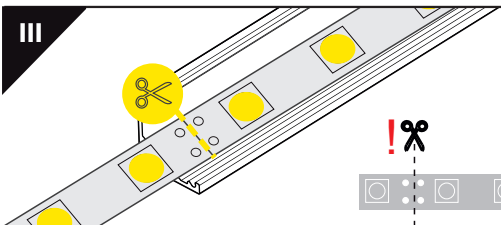

Dimensions of the space to install LED source.
Wymiary przestrzeni do zamontowania źródła LED.

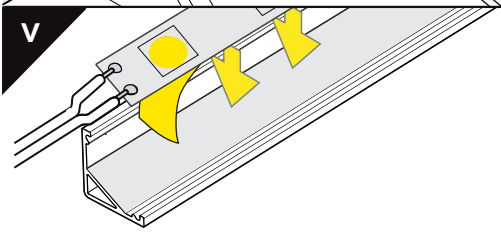
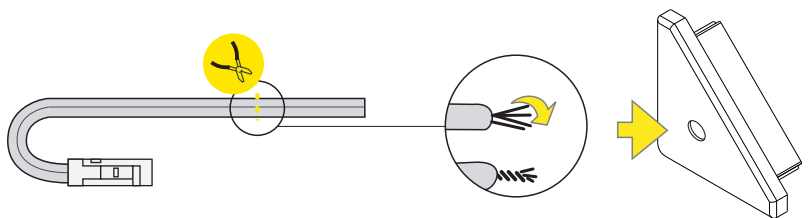
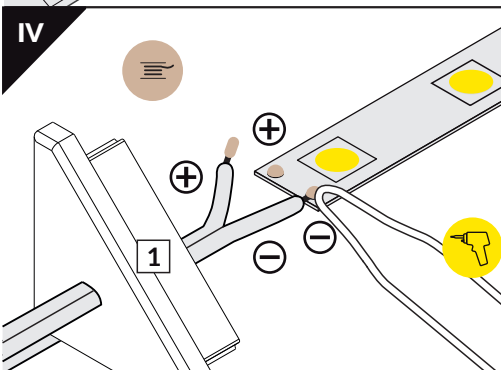

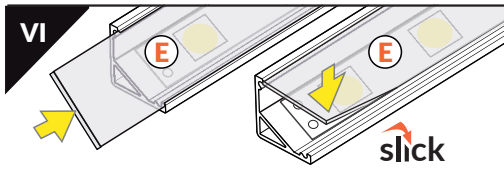

E slide cover/ klosz E wsuwany

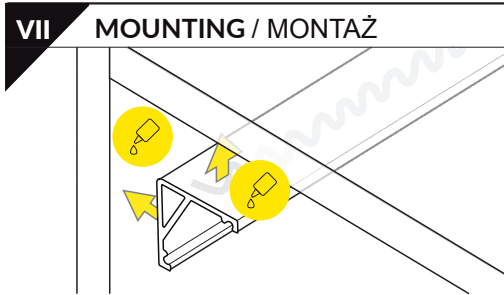

glue
klej montażowy

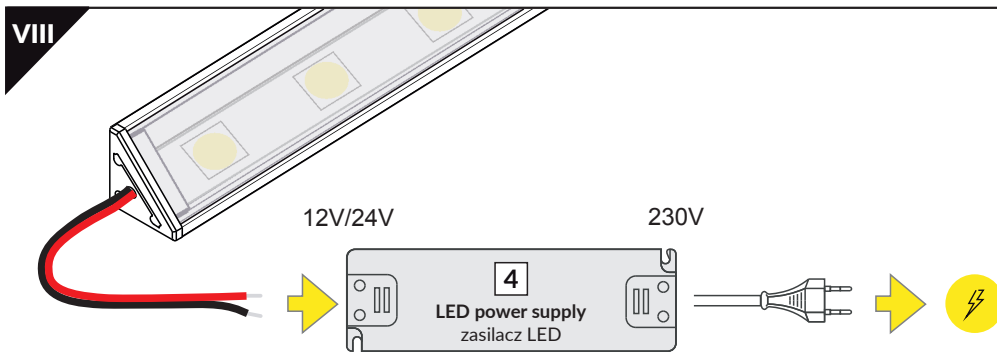

ACCESSORIES / AKCESORIA

- power switches
- controller + remote
- movement sensors
-
- włączniki
- sterownik + pilot
- czujniki ruchu