

VARIO30

SURFACE PROFILES

PROFILE NAWIERZCHNIOWE



scissors
nożyczki



hacksaw
piłka



glue
klej



drill
wiertarka











screwdriver
wkrętar



metal shears
nożyce do metalu



cotton gloves
rękawiczki

profiles profile	endings zaślepki	assistant profiles profil pomocnicze	mountings mocowania
 08 power supply cover VARIO30-08 osłona zasilacza VARIO30-08	08A, 08B 08C, 08D	 09 profile VARIO30-09 profil VARIO30-09	 Y¹ Y flexible mounting plate uchwyt Y sprężysty  Y² cone Y flexible mounting plate uchwyt Y sprężysty cone  T T mounting plate uchwyt T
 01 LED profile VARIO30-01 profil LED VARIO30-01	01	 10 profile VARIO30-10 profil VARIO30-10 FIX16	
 02 LED profile VARIO30-02 profil LED VARIO30-02	02		
 03 LED profile VARIO30-03 profil LED VARIO30-03	03		

PENDANT VARIANTS

WARIANTY WISZĄCE

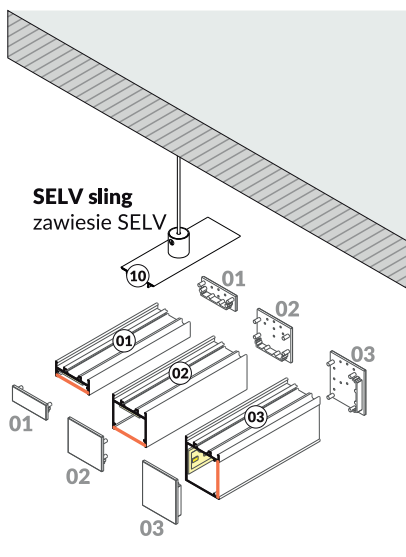

SURFACE VARIANTS

WARIANTY NAWIERZCHNIOWE

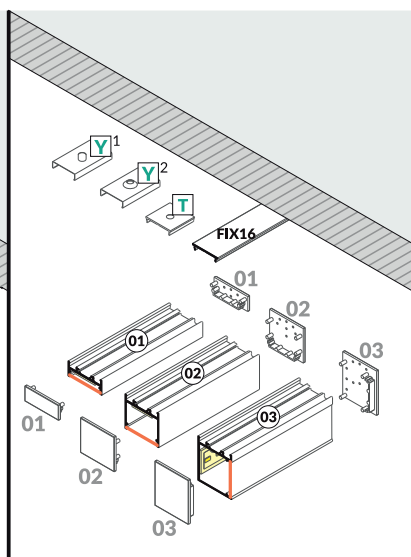

VARIANTS WITH POWER SUPPLY COVER

WARIANTY Z OSŁONĄ ZASILACZA

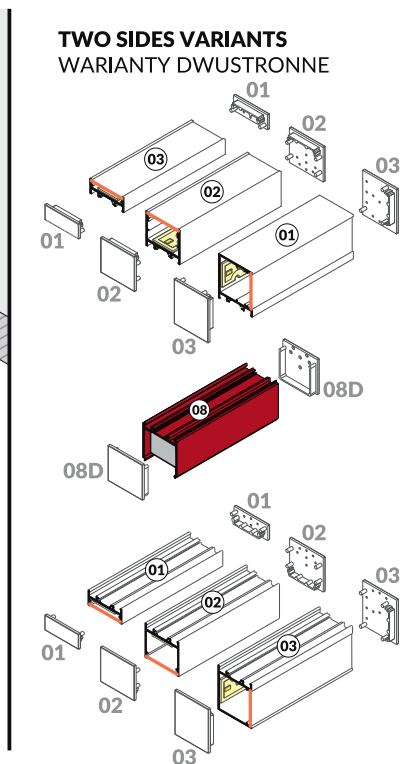
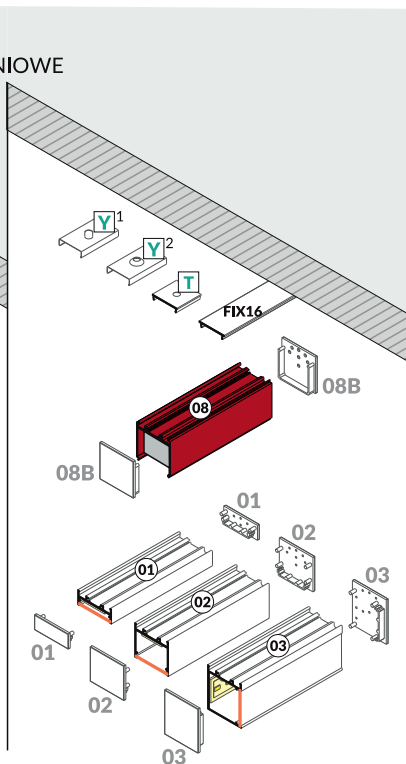
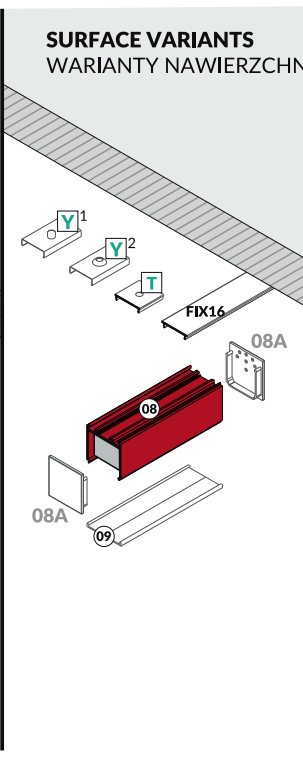
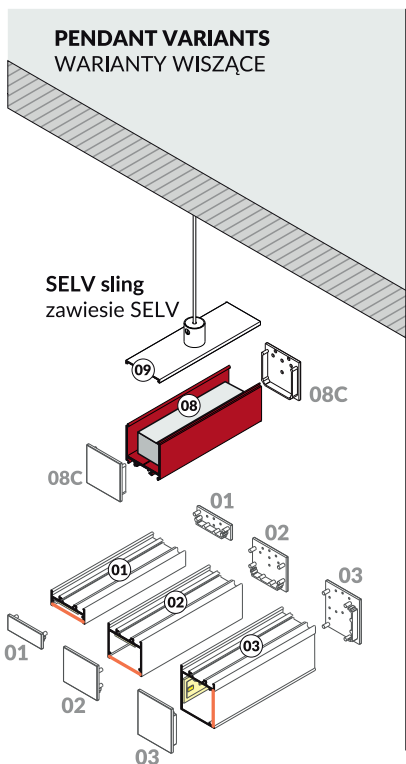

I

VARIO30-01
VARIO30-02
VARIO30-03
 diffuser / klosz
A9, C9, D9, E9

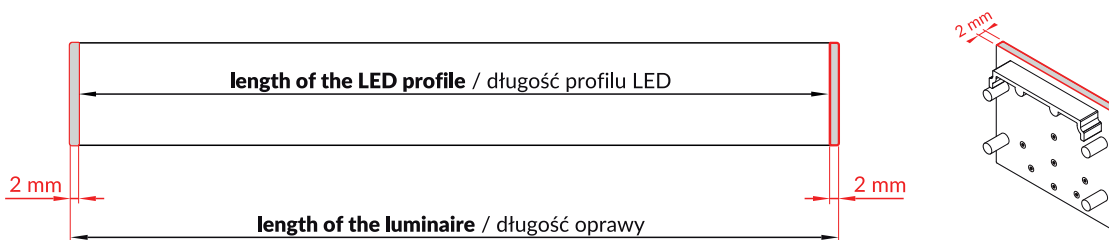

II

VARIO30-01
VARIO30-02
VARIO30-03
 diffuser / klosz
A9, C9, D9, E9

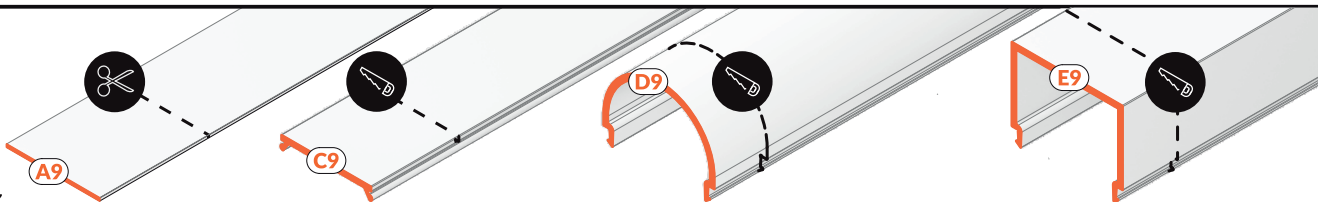

Note! The length of the cover is equal to the length of the profile.
Uwaga! Długość klosza równa jest długości profilu.

III

VARIO30-01
 diffuser / klosz
A9, C9

RECOMMENDED LED STRIP
 REKOMENDOWANA TAŚMA LED

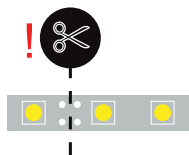
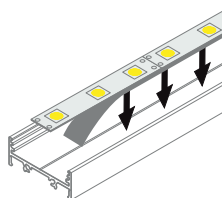

VARIO30-01
 diffuser / klosz
D9, E9

RECOMMENDED LED MODULE:
 REKOMENDOWANY MODUŁ LED:
PHILIPS Fortimo LED strip LV

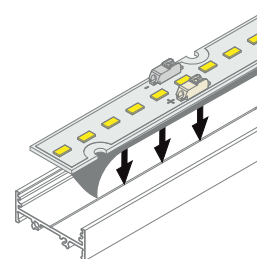

Note! Possible to use LED strip
 max 30 mm width
Uwaga! Możliwe użycie taśmy LED
 o maksymalnej szerokości 30 mm

**double-sided adhesive thermally
 conductive tape 15 mm x 50 mm**
 taśma termoprzewodząca dwustronna
 15 mm x 50 mm

VARIO30-02
VARIO30-03
 diffuser / klosz
A9, C9, D9, E9

RECOMMENDED LED MODULE:
 REKOMENDOWANY MODUŁ LED:
PHILIPS Fortimo LED strip LV

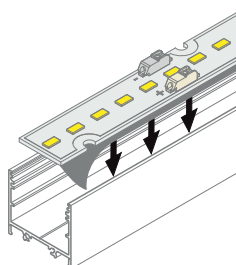

Note! Possible to use LED strip
 max 30 mm width
Uwaga! Możliwe użycie taśmy LED
 o maksymalnej szerokości 30 mm

**double-sided adhesive thermally
 conductive tape 15 mm x 50 mm**
 taśma termoprzewodząca dwustronna
 15 mm x 50 mm

IV ACCESSORIES / AKCESORIA

VARIO30 LED clamp
 docisk LED VARIO30

VARIO30-02
 diffuser / klosz
A9, C9, D9, E9

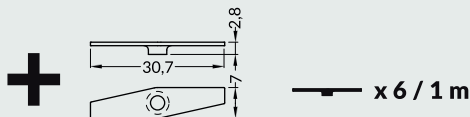

A9 C9 D9 E9

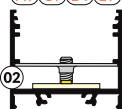

VARIO30-02

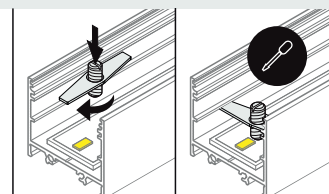

VARIO30 LED 1 clamp
docisk LED VARIO30 1

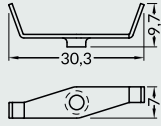

x 6 / 1 m

VARIO30-03
diffuser / klosz
A9, C9, D9, E9



A9 C9 D9 E9

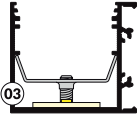

VARIO30-03

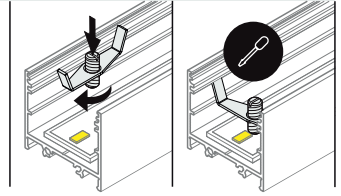

VARIO30 LED mounting
mocowanie LED VARIO30

VARIO30-02
VARIO30-03
diffuser / klosz
A9, C9, D9, E9

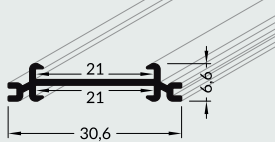

A9 C9 D9 E9

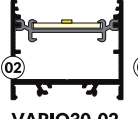

VARIO30-02

D9 E9

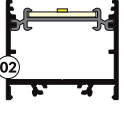

VARIO30-03

A9 C9 D9 E9

D9 E9

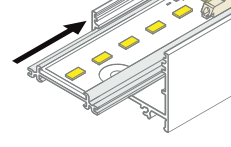
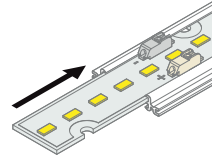
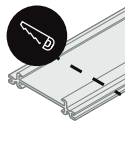
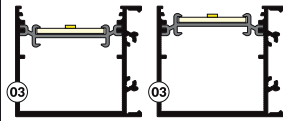

VARIO30 LED mounting
mocowanie LED VARIO30

VARIO30-02
VARIO30-03
diffuser / klosz
A9, C9, D9, E9

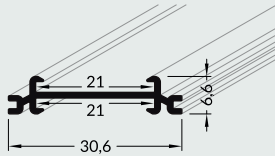

VARIO30 LED clamp
docisk LED VARIO30

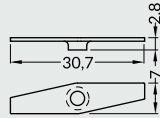

x 6 / 1 m

A9 C9 D9 E9

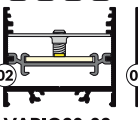

VARIO30-02

A9 C9 D9 E9

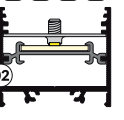

VARIO30-03

A9 C9 D9 E9

A9 C9 D9 E9

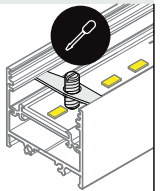
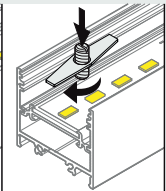
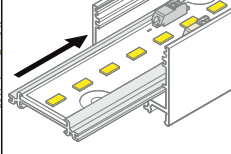
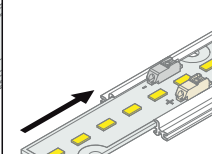
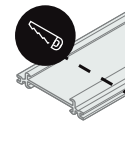
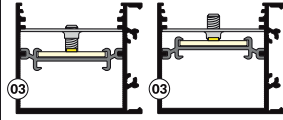

VARIO30 LED mounting
mocowanie LED VARIO30

VARIO30-02
VARIO30-03
diffuser / klosz
A9, C9, D9, E9

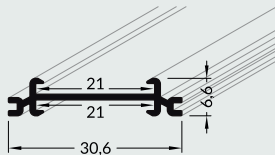

VARIO30 LED 1 clamp
docisk LED VARIO30 1

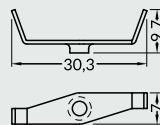

x 6 / 1 m

A9 C9 D9 E9

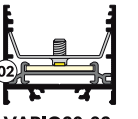

VARIO30-02

A9 C9 D9 E9

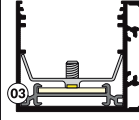

VARIO30-03

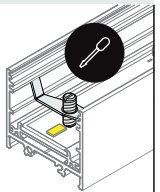
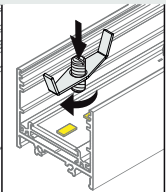
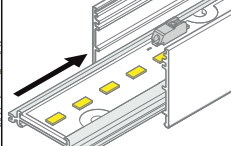
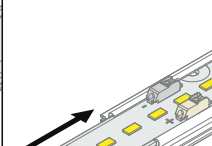
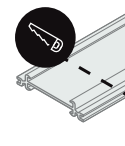

VARIO30-02
VARIO30-03
diffuser / klosz
A9, C9, D9, E9

VARIO30 reflector
odbłyśnik VARIO30

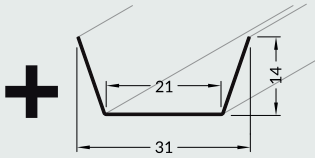

VARIO30 LED 1 clamp
docisk LED VARIO30 1

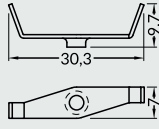

x 6 / 1 m

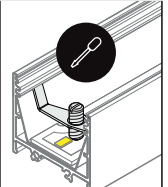
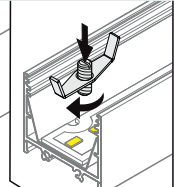
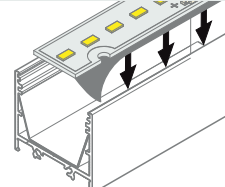
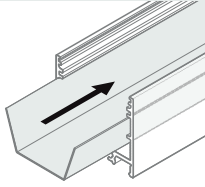
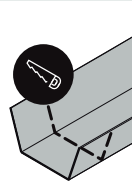

double-sided adhesive thermally conductive tape 15 mm x 50 m
taśma termoprzewodząca dwustronna 15 mm x 50 m

VARIO30-01
VARIO30-02
VARIO30-03
diffuser / klosz
A9, C9, D9, E9

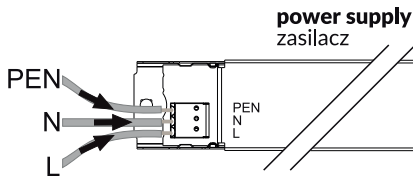

Note! Ending with marked space to bore the holes.
Possibility of buying dedicated screws.
Uwaga! Zaślepka z punktami do przewiercenia otworów.
Istnieje możliwość zakupu dedykowanych wkrętów.

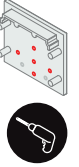

VARIO30-01
VARIO30-02
VARIO30-03
diffuser / klosz
A9

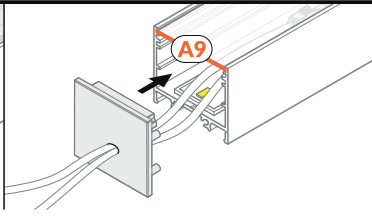
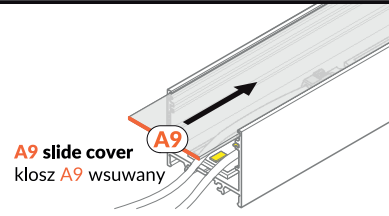

VARIO30-01
VARIO30-02
VARIO30-03
diffuser / klosz
C9

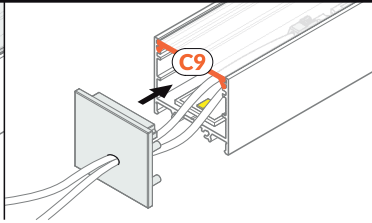
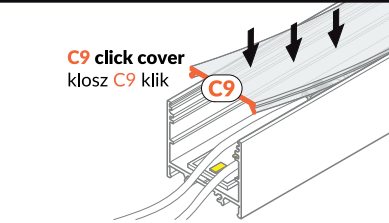

VARIO30-01
VARIO30-02
VARIO30-03
diffuser / klosz
E9
ending / zaślepka
E9

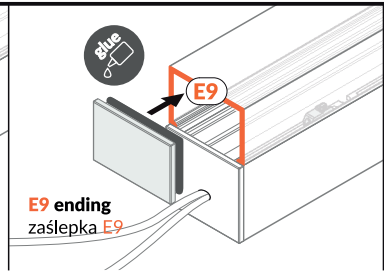
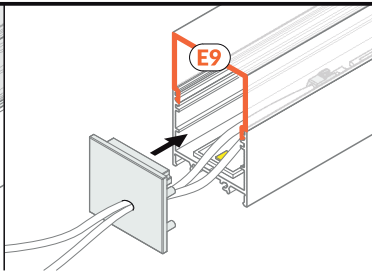
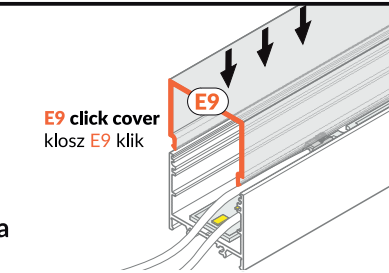

VARIO30-01
VARIO30-02
VARIO30-03
diffuser / klosz
D9
ending / zaślepka
D9

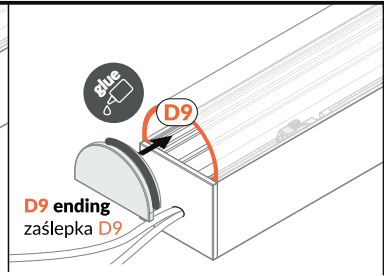
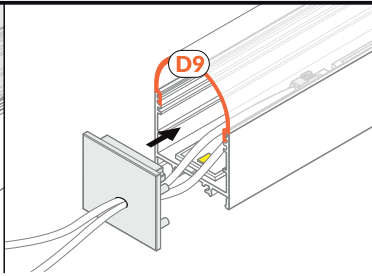
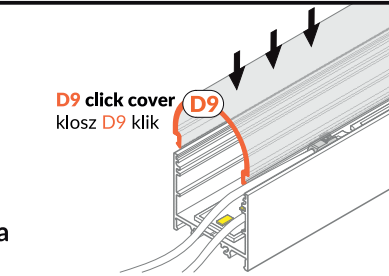

VARIO30-01
VARIO30-02
VARIO30-03
diffuser / klosz
A9, C9, D9, E9
VARIO30-08

VARIO30-08
power supply cover
osłona zasilacza

VARIO30-01
VARIO30-02
VARIO30-03

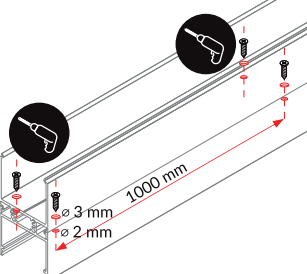
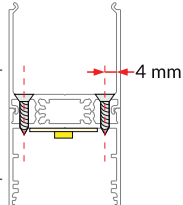

wires cover Ø 5 mm
osłona przewodów Ø 5 mm

VARIO30-08
power supply cover
osłona zasilacza

VARIO30-01
VARIO30-02
VARIO30-03

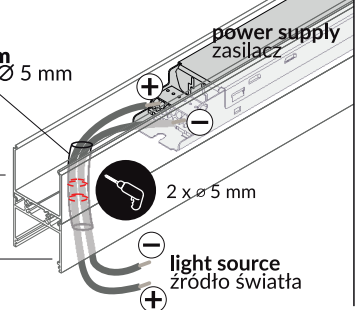

VIII METAL ENDINGS
ZAŚLEPKI METALOWE

VARIANT 16-E9 / WARIANT 16-E9

diffuser / klosz

E9

VARIO30-16-E9 metal ending
zaślepka VARIO30-16-E9 metal

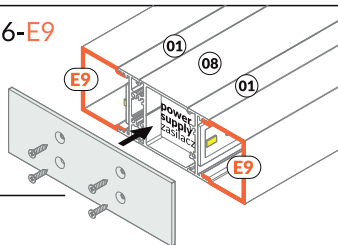

VARIANT 19-E9 / WARIANT 19-E9

diffuser / klosz

E9

VARIO30-19-E9 metal ending
zaślepka VARIO30-19-E9 metal

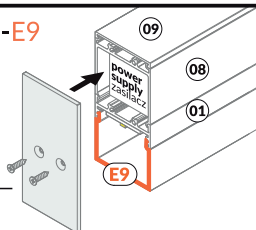

VARIANT 27 / WARIANT 27

diffuser / klosz

A9, C9, E9, D9

VARIO30-27 metal ending
zaślepka VARIO30-27 metal

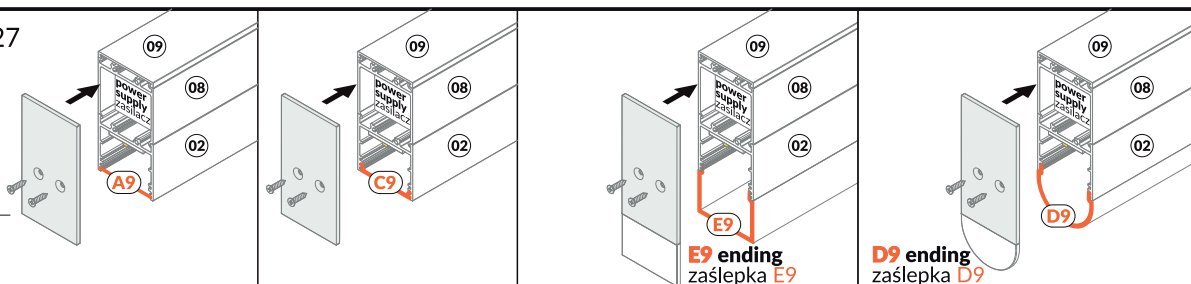

VARIANT 32 / WARIANT 32

diffuser / klosz

A9, C9, E9, D9

VARIO30-32 metal ending
zaślepka VARIO30-32 metal

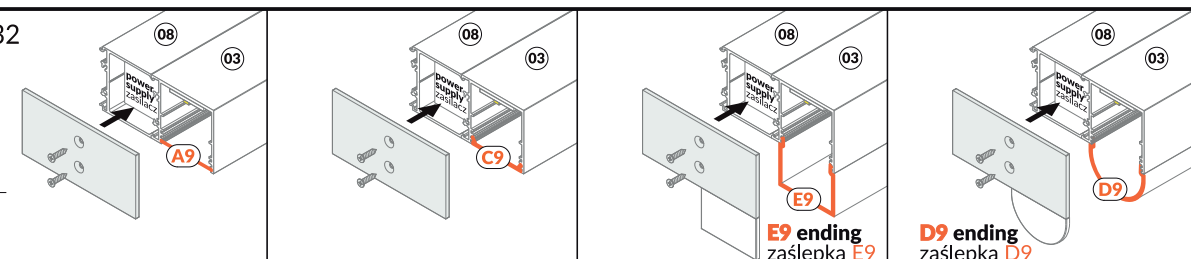

VARIANT 34 / WARIANT 34

diffuser / klosz

A9, C9, E9, D9

VARIO30-34 metal ending
zaślepka VARIO30-34 metal

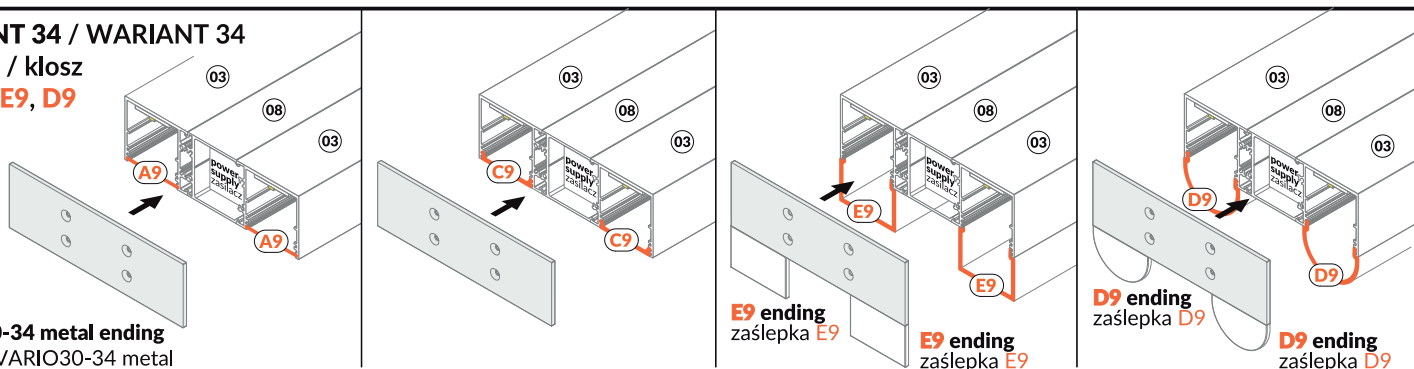

IX MOUNTING / MONTAŻ

VARIO30-01
VARIO30-02
VARIO30-03
diffuser / klosz
A9, C9, D9, E9

Y flexible mounting plate
uchwyt Y sprężysty

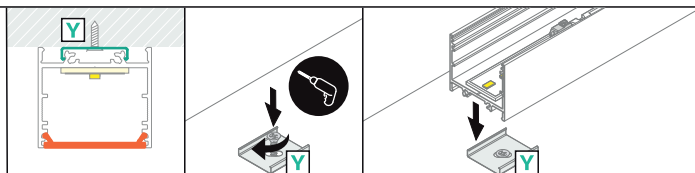

cone Y flexible mounting plate
uchwyt Y sprężysty cone

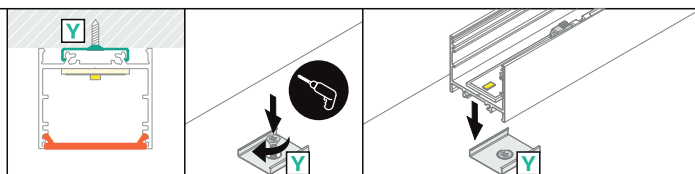

T mounting plate
uchwyt T

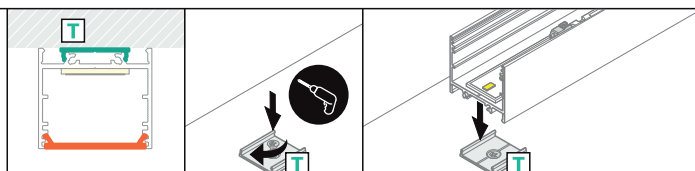

X

VARIO30-01
VARIO30-02
VARIO30-03
diffuser / klosz
A9, C9, D9, E9

VARIO30-10

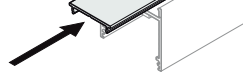

FIX16

**VARIO30-08**

VARIO30-09

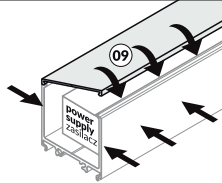
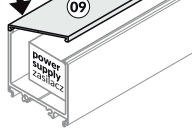
**XI CONNECTORS / ŁĄCZNIKI**

VARIO30-02
VARIO30-03
diffuser / klosz
A9, C9, D9, E9

Available angular connectors:
 Dostępne łączniki kątowe:

1. **VARIO30-02 connector 60 deg** / łącznik VARIO30-02 st
2. **VARIO30-02 connector 90 deg** / łącznik VARIO30-02 st
3. **VARIO30-02 connector 90 deg bent** / łącznik VARIO30-02 st gięty
4. **VARIO30-02 connector 135 deg** / łącznik VARIO30-02 st
5. **VARIO30-02 connector 180 deg** / łącznik VARIO30-0203 st
6. **VARIO30-0203 connector 180 deg** / łącznik VARIO30-0203 st
7. **VARIO30-02 270 connector deg bent** / łącznik VARIO30-02 st gięty

CONNECTION POSSIBILITIES
MOŻLIWOŚCI ŁĄCZENIA



60°



90°



90° bent / gięty



120°



135°



180°



270° bent / gięty

VARIO30-02
VARIO30-03
diffuser / klosz
A9, C9, D9, E9

connector 180 deg
 łącznik 180 st

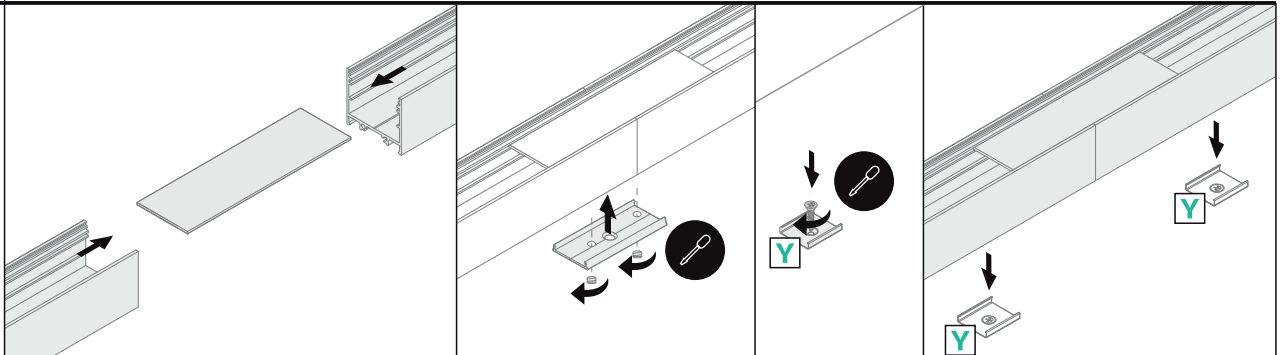

VARIO30-02
diffuser / klosz
A9, C9, D9, E9

connector:
 60 deg, 90 deg,
 90 deg bent, 135 deg,
 270 deg bent
 łącznik:
 60 st, 90 st, 90 st gięty,
 135 st, 270 st gięty

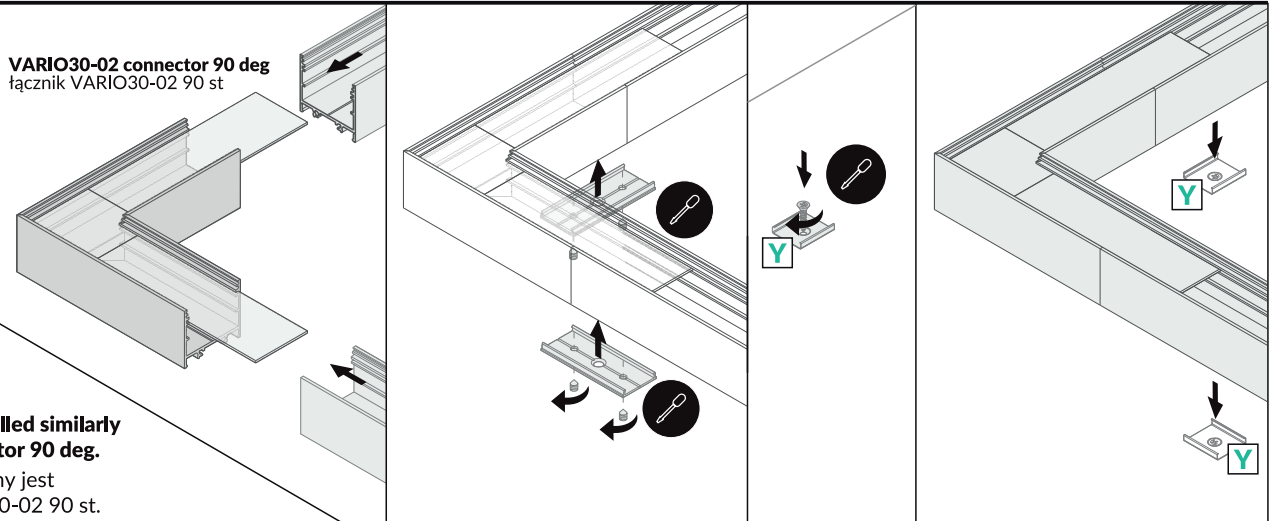

VARIO30-02 connector 90 deg
 łącznik VARIO30-02 90 st

Every connector is installed similarly
to VARIO30-02 connector 90 deg.

Każdy łącznik montowany jest
 analogicznie do VARIO30-02 90 st.

XII POWER SUPPLY / ZASILANIE

VARIO30-01
VARIO30-02
VARIO30-03
diffuser / klosz
A9, C9, D9, E9

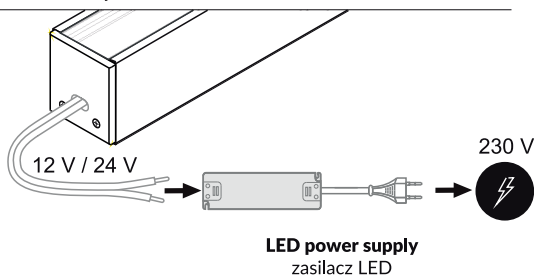
VARIO30-08

LED power supply
 zasilacz LED

ACCESSORIES / AKCESORIA

SELV sling - for more information
check the SELV sling manual
 zawiesie SELV - więcej informacji w instrukcji

WIRELI
 www.wireli.cz