

DIAGONAL14 F/TY

RECESSED PROFILE / PROFIL WPUSTOWY

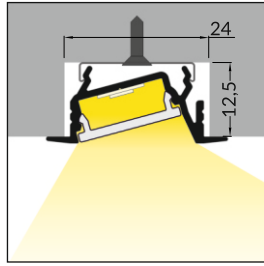

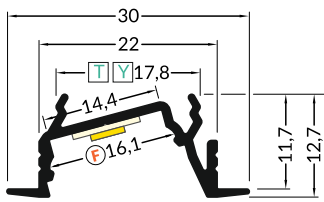



 max 14 mm

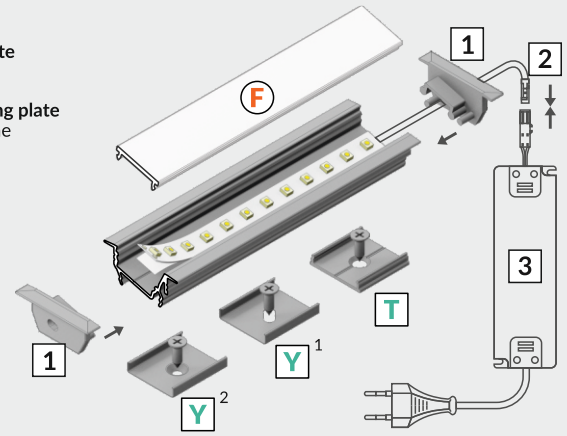

- F** F click cover
klosz F klik
- Y**¹ Y flexible mounting plate
uchwyt Y sprężysty
- Y**² cone Y flexible mounting plate
uchwyt Y sprężysty cone
- T** T mounting plate
uchwyt T

- 1** DIAGONAL14 ending
with hole
zaślepka DIAGONAL14
z otworem
- 2** power supply cable
kabel zasilania
- 3** LED power supply
zasilacz LED



-  scissors
nożyczki
-  hacksaw
piłka
-  pliers
kombinerki
-  solder
cyna
-  soldering iron
lutownica
-  screwdriver
wkrętek
-  glue
klej

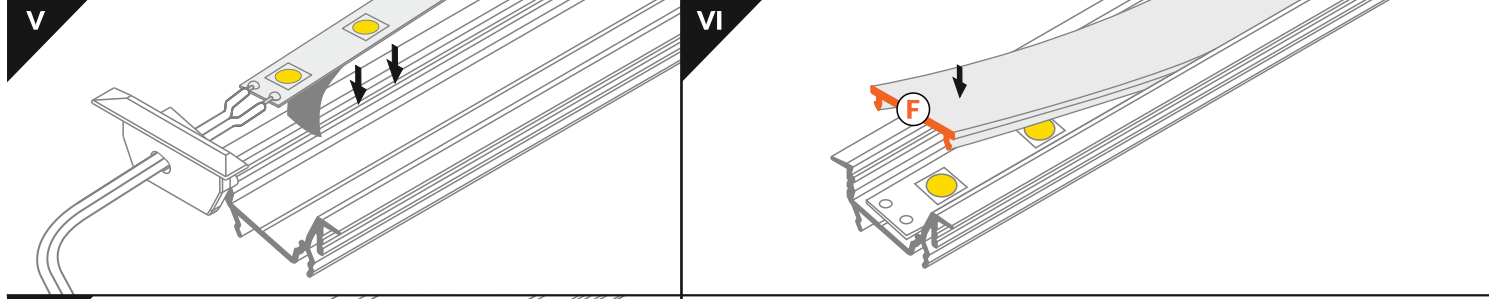
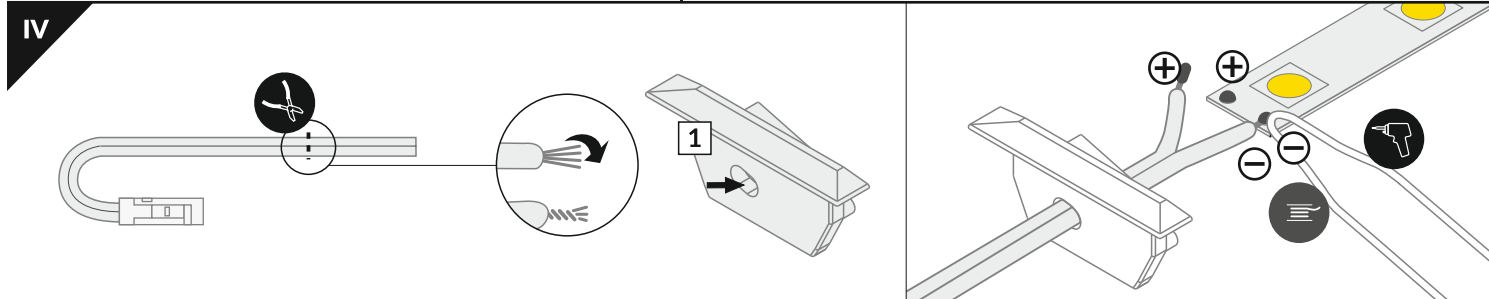
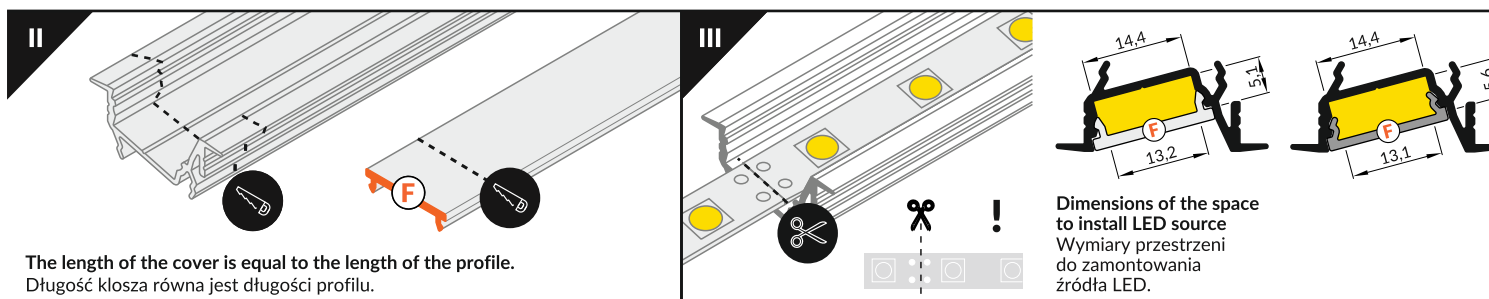
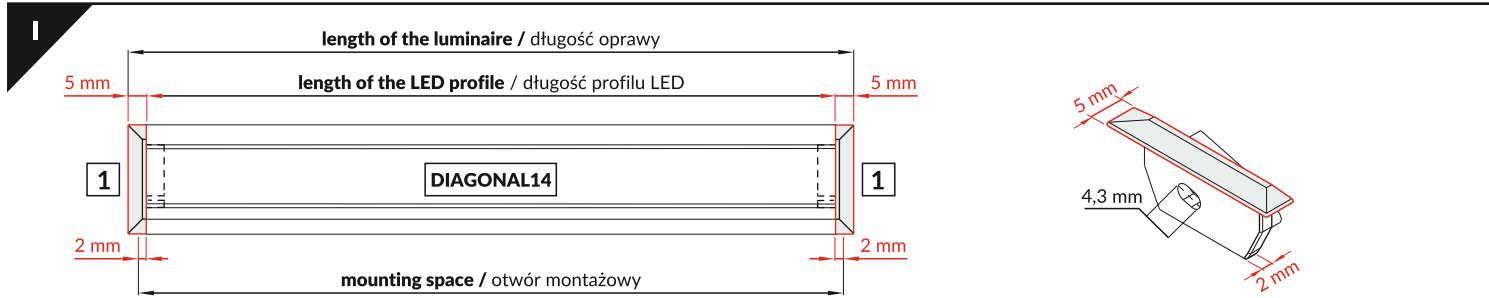

VIII MOUNTING / MONTAŽ

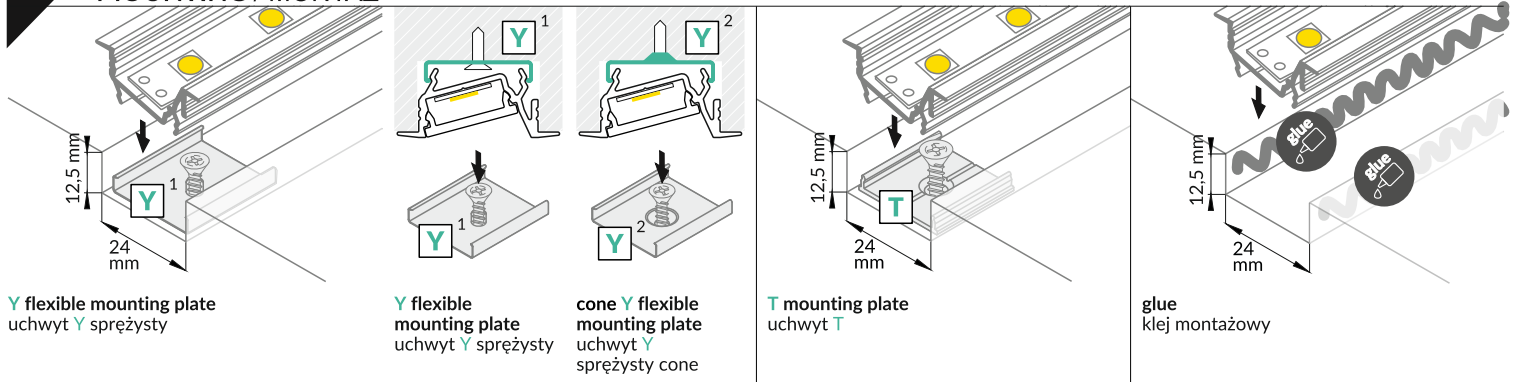

IX POWER SUPPLY / ZASILANIE

